

robot coupe[®]

New
Register
your product
on line

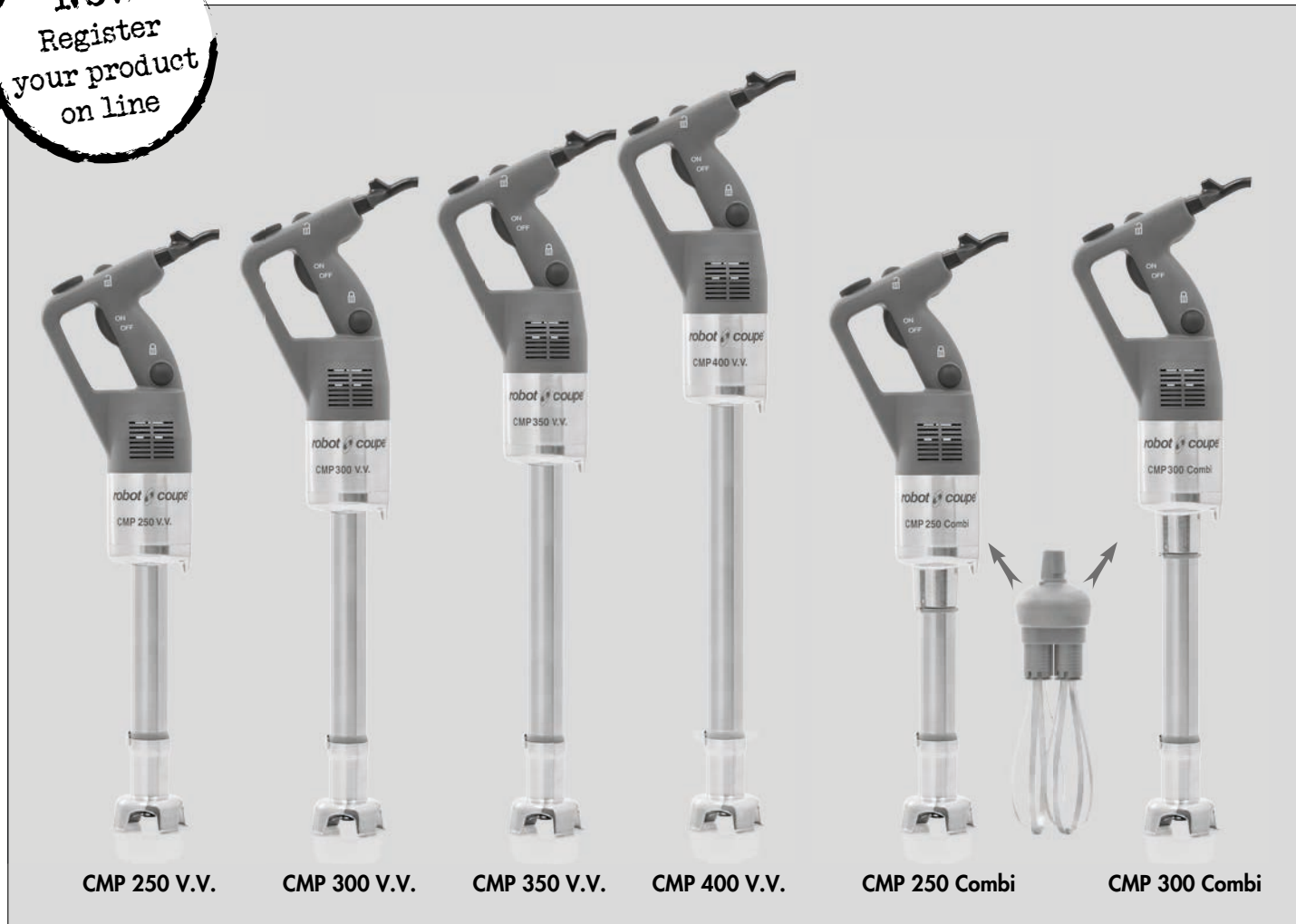

CMP 250 V.V.

CMP 300 V.V.

CMP 350 V.V.

CMP 400 V.V.

CMP 250 Combi

CMP 300 Combi

CMP 250 V.V.

CMP 300 V.V.

CMP 350 V.V.

CMP 400 V.V.

CMP 250 Combi

CMP 300 Combi

www.robot-coupe.com

@ Register your product on line

The screenshot displays the Robot-Coupe website's support section. At the top, the navigation bar includes the company logo, links for 'The company', 'Contact us', 'Restricted Area', and 'Select your country...'. Below this, a menu bar features 'CATALOGUE', 'SELECTION GUIDE', 'LEAFLETS', 'VIDEOS', 'OUR SUPPORT', and a search bar. The main heading is 'SUPPORT'. The page is divided into two columns. The left column, titled 'Register your product online', provides instructions and a list of required information: 'Product serial number' and 'Purchase date'. A button labeled 'Register my product now' is at the bottom of this column. The right column, titled 'Access the Robot-Coupe after-sales service', shows a preview of the authentication page with fields for 'Identifiant', 'Mot de passe', and 'Email', along with a 'Pour nous contacter' link. A button labeled 'Access the Robot-Coupe after-sales service' is at the bottom of this column.

robot coupe®

EU Declaration of Conformity

Robot-Coupe® SNC declares that all the machines subject of these original instructions, as well as their accessories and their packaging, comply with:

- the essential requirements of the following European directives and with the corresponding national regulations :
 - Directive "Machinery" **2006/42/EC**,
 - Directive "Low Voltage" **2014/35/EU**,
 - Directive "Electromagnetic Compatibility" **2014/30/EU**,
 - Directive "Reduction of Hazardous Substances in Electrical Equipment" (RoHS) **2011/65/EU**,
 - Directive "Waste Electrical and Electronic Equipment" (WEEE) **2012/19/EU**,
- Regulation **(EC) No 1907/2006** (latest consolidated version) "concerning the Registration, Evaluation, Authorisation and Restriction of Chemicals (REACH)" and as such, no product, accessory and their packaging sold by Robot-Coupe® SNC, contains any substance on the European Chemical Agency (ECHA) candidate list and considered of very high concern.
- Regulation **(EC) No 1935/2004** "Materials and articles intended to come into contact with food" modified by regulation (EC) No 596/2009.
- Regulation **(EC) No 2023/2006** "Good manufacturing practice for materials and articles intended to come into contact with food".
- Regulation **(EU) No 10/2011** "Plastic materials and articles intended to come into contact with food", as well as all relevant (EU) regulations which modify, correct and/or rectify it, as at the date of this declaration, the regulations (EU) No 1282/2011, 1183/2012, 202/2014, 865/2014, 2015/174, 2016/1416, 2017/752, 2018/79, 2018/213, 2018/831 and 2019/37.
- the provisions of the following harmonized European standards and the standards specifying the safety and hygiene requirements:
 - **EN ISO 12100:2010** Safety of machinery – General principles for design,
 - **EN 60204-1:2006** Safety of machinery – Electrical equipment of machines,
 - **EN 60529** Degrees of protection provided by enclosures (IP Code):
 - IP 55 for the electric controls,
 - IP 34 for the other parts of the machine,
- and according to the category of the apparatus, with the provisions of the following harmonized European standards specifying the safety and hygiene requirements:
 - **EN 454** Planetary Mixers,
 - **EN 1678** Vegetable Cutting Machines (and Juice Extractors),
 - **EN 12852** Food Processors and Blenders,
 - **EN 12853** Hand-Held Blenders and Whisks (Power Mixers),
 - **EN 13208** Vegetable Peelers,
 - **EN 13621** Salad Dryers,
 - **EN 14655** Baguette Slicers.

"R019"

Montceau-en-Bourgogne, on March 1st, 2019

Jean-Marie LOZANO
Director of Industrial Operations



SUMMARY

■ WARRANTY

■ IMPORTANT WARNING

■ INTRODUCTION TO YOUR NEW POWER MIXER

■ SWITCHING ON THE APPLIANCE

- Advice on electrical connections

■ OPERATING THE APPLIANCE

- Starting and stopping the power mixer
- Continuous operation
- Variable-speed operation
- Power cord

■ WORKING POSITION

- Blade function
- Whisk function

■ ASSEMBLING & DISMANTLING

- Blade function
- Whisk function

■ USES & EXAMPLES

■ PAN SUPPORT

- Universal support
- Adjustable support

■ HYGIENE

■ CLEANING

- Motor unit
- Foot and bell
- Blades
- Whisk holder
- Whisks

■ MAINTENANCE

- Blades
- Whisks
- Power cord
- Foot seal
- Seal ring

■ TECHNICAL SPECIFICATIONS

- Weight
- Dimensions
- Working height
- Noise level
- Electrical data

■ SAFETY

■ PROBLEMS

■ STANDARDS

■ TECHNICAL DATA

- Electric and wiring diagrams

ROBOT-COUCPE S.N.C., LIMITED WARRANTY

Your new ROBOT-COUCPE appliance is warranted to the original buyer for a period of one year from the date of sale if you bought it from ROBOT-COUCPE S.N.C.

If you bought your ROBOT-COUCPE product from a distributor your product is covered by your distributor's warranty (Please check with your distributor terms and conditions of the warranty).

The ROBOT-COUCPE S.N.C. limited warranty is against defects in material and/or workmanship.

THE FOLLOWING ARE NOT COVERED BY THE ROBOT-COUCPE S.N.C. WARRANTY:

1 - Damage caused by abuse, misuse, dropping, or other similar damage caused by or resulting from failure to follow assembly, operating, cleaning, user maintenance or storage instructions.

2 - Labour to sharpen and/ or replacements for blades which have become blunt, chipped or worn after a normal or excessive period of use.

3 - Materials or labour to replace or repair scratched, stained, chipped, pitted, dented or discoloured surfaces, blades, knives, attachments or accessories.

4 - Any alteration, addition or repair that has not been carried out by the company or an approved service agency.

5 - Transportation of the appliance to or from an approved service agency.

6 - Labour charges to install or test new attachments or accessories (i.e., bowls, discs, blades, attachments) which have been arbitrarily replaced.

7 - The cost of changing direction-of-rotation of electric motors (Installer is responsible).

8 - SHIPPING DAMAGES. Visible and latent defects are the responsibility of the freight carrier. The consignee must inform the carrier and consignor immediately, or upon discovery in the case of latent defects.

KEEP ALL ORIGINAL CONTAINERS AND PACKING MATERIALS FOR CARRIER INSPECTION.

Neither ROBOT-COUCPE S.N.C. nor its affiliated companies or any of its distributors, directors, agents, employees, or insurers will be liable for indirect damage, losses, or expenses linked to the appliance or the inability to use it.

The ROBOT-COUCPE S.N.C. warranty is given expressly and in lieu of all other warranties, expressed or implied, for merchantability and for fitness toward a particular purpose and constitutes the only warranty made by ROBOT-COUCPE S.N.C. France.

IMPORTANT WARNING



WARNING: In order to limit accidents such as electric shocks or personal injury, and in order to limit material damage due to misuse of the appliance, please read these instructions carefully and follow them strictly. Reading the operating instructions will help you get to know your appliance and enable you to use the equipment correctly. Please read these instructions in their entirety and make sure that anyone else who may use the appliance also reads them beforehand. Our equipment is designed for professional use and must not be used by children under any circumstances.

UNPACKING

- **WARNING** - some of the tools are very sharp e.g. blades, etc..

INSTALLATION

- We recommend that you install your appliance on its wall frame.

CONNECTION

- Always check that your mains supply corresponds to that indicated on the identification plate on the motor unit and that it can withstand the amperage.
- Never plug your appliance into the mains supply before placing it inside the preparation bowl.

HANDLING

- Always take care when handling the blades, as they are extremely sharp.

ASSEMBLY PROCEDURES

- Follow the various assembly procedures carefully (see page 7) and make sure that all the attachments are correctly positioned.

USE

- Never try to override the safety systems.
- Never insert an object into the preparation.
- Never switch the appliance on unless it has been placed in the preparation bowl.
- Before dismantling the foot, bell or whisk always check that the power mixer is unplugged.
- We recommend that you tilt the appliance at a slight angle to prevent the bell from touching the bottom of the container.

 **WARNING**

Procedure to follow if the stick blender is accidentally immersed during use.

- 1) Do not touch either the power mixer, the bowl or the work surface.**
- 2) Unplug the mixer's power cord from the wall socket.**
- 3) Remove the power mixer from the preparation.**
- 4) Tilt the power mixer to drain off as much liquid as possible.**
- 5) Do not switch the power mixer back on, as there is still a risk of electrocution.**
- 6) Send the power mixer to a Robot-Coupe approved after-sales service to have the electrical components cleaned and dried.**

CLEANING

- As a precaution, always unplug your appliance before cleaning it.
- Always clean the appliance and its attachments at the end of each cycle.
- Never immerse the motor unit in water.
- For parts made from aluminum, use cleaning fluids intended for aluminum.
- For plastic parts, do not use detergents that are too alkaline (e.g., containing too much caustic soda or ammonia).
- Robot-Coupe can in no way be held responsible for the user's failure to follow the basic rules of cleaning and hygiene.

MAINTENANCE

- Before opening the motor housing, it is absolutely vital to unplug the appliance.
- Check the seals and washers regularly and ensure that the safety devices are in good working order.
- It is particularly important to maintain and check the attachments since certain ingredients contain corrosive agents, e.g. citric acid.
- Never operate the appliance if the power cord or plug has been damaged or if the appliance fails to work properly or has been damaged in any way.
- Do not hesitate to contact your local Maintenance Service if something appears to be wrong.

INTRODUCTION TO YOUR NEW POWER MIXER

Robot-Coupe has developed a whole range of power mixer. Their technical characteristics are shown in the table below.

Models	Speed variation	Mixer attachment	Whisk attachment	Capacity Litres
CMP 250 V.V.	●	250 mm		15
CMP 300 V.V.	●	300 mm		30
CMP 350 V.V.	●	350 mm		45
CMP 400 V.V.	●	400 mm		73
CMP 250 Combi	●	250 mm	220 mm	15
CMP 300 Combi	●	300 mm	220 mm	30
CMP 250 FW	●		220 mm	15

These models are working tools that are perfectly suited to the needs of their users. **The mixer function** will allow you to make soups, vegetable purées and pulps without any problem, while you will find that the **whisk function** is ideal for making pancake batter, mayonnaise, beaten egg whites, chocolate mousse, butter sauces, whipped cream or smooth fromage frais.

The whisk attachment is equipped with a metallic gear box with a plastic body, even more resistant when processing preparations such as pan cakes.

The **variable-speed** function will enable you to adjust the speed to suit each preparation and to start the processing at a lower speed in order to reduce splashing.

Each power mixer is supplied with a **wall support** for easy storage.

The simple design of these appliances allows the assembly and dismantling of the moving parts in no time at all, to ease maintenance and cleaning.

These instructions contain important information that will enable you to extract the greatest return on your investment.

We therefore strongly advise you to read these instructions carefully before using the appliance.

In blade function

Thanks to an **extremely powerful motor**, they can process quantities of 15 litres to 73 litres according to the model. Their **rapidity** and the **quality of the finished product are beyond reproach.**

In whisk function

In the whisk function, all three models can process:
2 to 35 egg whites
1 to 30 kg purée.

SWITCHING ON THE APPLIANCE

• ADVICE ON ELECTRICAL CONNECTIONS

This class II appliance (double insulation) requires a single-phase alternating current but does not need an earthed socket. The universal-type motor is fitted with an interference suppressor.

The power supply must be protected by a differential circuit breaker and a 10 A fuse.

Check that you have a standard 10/16 A single-phase socket.

Make sure that the voltage of your power supply matches that shown on the identification plate of your appliance.

Robot-Coupe supplies these models with different types of motors: 230 V/50 Hz for power supplies of 220 V to 240 V.

120 V / 60 Hz.

220 V / 60 Hz.

The power mixer is supplied with a single-phase plug connected to a power cord.

OPERATING THE APPLIANCE

• STARTING AND STOPPING THE POWER MIXER

1. Check that the control button (CB) is in the released position.
2. Connect the power mixer to the power supply.
3. Insert the foot into the preparation.
4. Press and hold down the safety button (SB).
5. Press the control button (CB), and the power mixer will start up.
6. Release the safety button (SB).

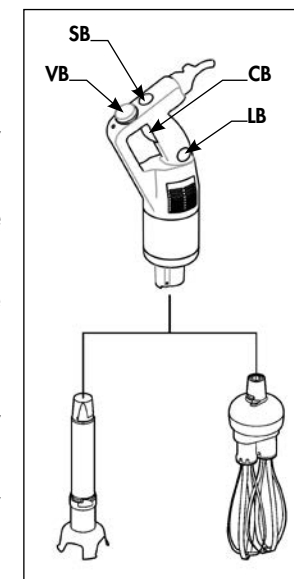

7. To stop the power mixer, release the control button (CB).

• CONTINUOUS OPERATION

Follow steps 1 to 6 above, then:

7. While the control button (CB) is in the depressed position, press the locking button (LB)
8. Release the control button (CB).
9. Release the locking button (LB), and the power mixer will function continuously.

10. To stop the power mixer, press and release the control button (CB).

• VARIABLE-SPEED OPERATION

Follow steps 1 to 6 above, then:

7. Change the speed of the motor by turning the variable speed button (VB) towards the maximum or minimum as required.

Whisk function: speed between **500** and **1,800** rpm.

Mixer function: speed between **2,300** and **9,600** rpm.

It is advisable to start at a low speed when using the whisk.

With the self-regulating speed system, once you have selected a speed, it will remain constant, even if the consistency of your mixture changes.

• POWER CORD

After cleaning the machine, wind the cord around the specially designed lugs, without stretching it too much. This will prolong its lifespan.



WORKING POSITION



WARNING

To ensure maximum safety regardless of your working position, we strongly recommend positioning both hands as indicated below and always as far as possible from any moving and cutting parts.

• BLADE FUNCTION

For greater control, we recommend that you hold the power mixer by the handle and the bottom of motor unit. Furthermore, we recommend that you tilt the power mixer at a slight angle to prevent the bell from touching the bottom of the container.



The power mixer can equally be rested against the rim of the container, but must be tilted, and the bell must not touch the bottom of the container.

In this case, it is best to place your free hand on the handle guard (or at least as far away as possible from any moving and cutting parts).



If using a support on top of the pan, ensure that the power mixer is positioned in the centre of the support, that it is at a slight angle, and that the bell is not touching the bottom of the container.

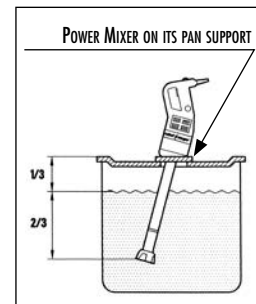

Always make sure that the bell is sufficiently immersed to avoid splashing and that the air vents of the motor unit does not come into contact with any liquid.

For optimum efficiency, two thirds of the foot should be immersed in the preparation.

• WHISK FUNCTION

You can also hold the appliance by the handle with one hand, leaving the other hand free to hold the bowl, if necessary.



While you process the preparation, we recommend that you move the whisks around in the bowl, in order to ensure that the mixture is completely homogeneous.

We strongly advise you to keep the whisks from touching the sides of the bowl. For maximum efficiency, at least one-fifth of the whisk length should be immersed. We also strongly advise you to start the processing at a low speed.

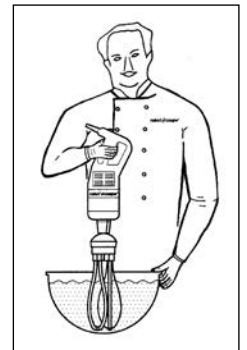

ASSEMBLING & DISMANTLING

• BLADE FUNCTION

Attaching the tube to the motor unit.
(only for CMP Combi)

- Check that the appliance is not plugged in.
- Align the flat side of **A** the conical part **C** of the tube with catch **B** into the aluminium casing.
- Insert the whole of the conical part **C** of the tube into the aluminium casing.

- Turn the tube in the direction of the arrow (see figure) until it is locked into place moderately tightly.

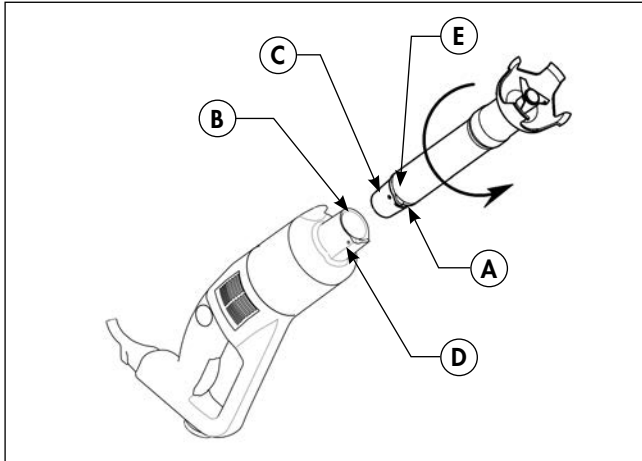

Removing the tube from the motor unit (only for CMP Combi)

- Check that the appliance is unplugged.
- Turn the tube in the opposite direction to that used when attaching it.
- When it will go no further, remove the tube of the aluminium casing.

Attaching the bell from the tube

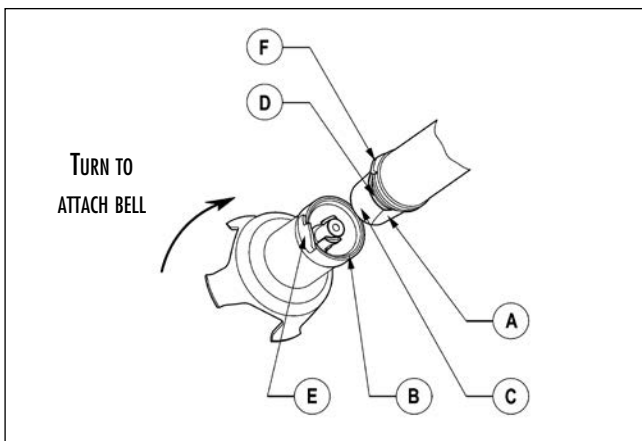

- Check that the machine is not plugged in.
- Align the flat side of **A** the conical part of the tube with catch **B** on the inside of the bell.
- Insert the conical part **C** into the bell. With the washer touching the tube seal **D**, turn the bell in the direction of the arrow (see above figure) to lock the bell lug **E** and tube lug **F** together moderately tightly.

Removing the bell from the tube

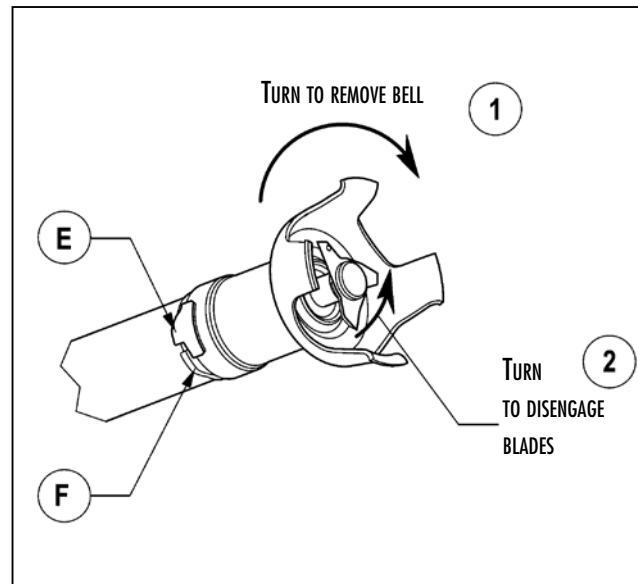

- Check that the machine is not plugged in.
- Turn the bell in the direction of arrow **1** (see next figure) to separate the bell lug **E** from the tube lug **F**. Remove the bell.

If jammed, turn the blades inside the bell in the direction of arrow **2** to disengage them from the drive shaft.

Removing the blade

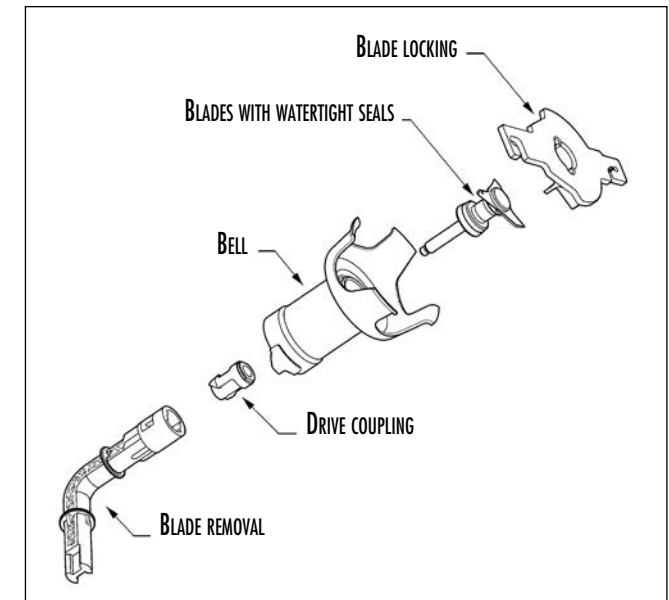

- To remove the blade safely, hold them with the tool provided or an oven glove or a thick cloth.
- Using the removal tool, unscrew the drive coupling.
- As soon as the drive coupling has been unscrewed, the blade can be removed for cleaning.

• WHISK FUNCTION (CMP Combi)

Attaching the whisk holder to the motor unit.

- Check that the machine is not plugged in.
- Align the flat side **A** of the conical part **C** of the whisk holder with the catch **B** on the inside of the aluminium casing.
- Insert the whole of the conical part **C** of the whisk holder into the aluminium casing.
- Turn the whisk holder in the direction of the arrow (see figure) until it is locked into place moderately tightly.

USES & EXAMPLES

The mixer function makes it possible to carry out all types of processing in the minimum of time, while the whisk function enables you to whisk and mix the preparation. We thus recommend that you supervise all food preparations carefully in order to obtain the best results.

CATERING AND RESTAURANT WORK

Blade Function

- Soups
- Vegetable purees : carrots, spinach, celery, turnips, French beans, etc.
- Mousses : vegetable, fish...
- Fruit compotes
- Sauces : green, rouille, remoulade, cream emulsions, tomato or parsley...
- Bisques : langoustines and shellfish...
- Pancake batter

Whisk function

- Mashed potatoes (fresh or instant).
- Pancake batter
- Mayonnaise
- Beaten egg whites
- Chocolate mousse
- Butter sauces
- Whipped cream
- Smooth fromage frais
- Mashed potato (fresh or instant)

CHEMICAL & PHARMACEUTICAL LABORATORY WORK

- Mixing : making ointments, creams, paste..., emulsions.

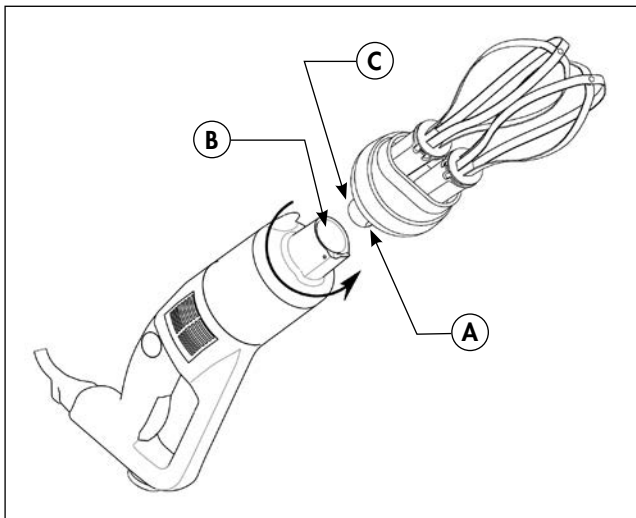

Removing the casing

- Check that the machine is not plugged in.
- Turn the whisk holder in the opposite direction to that used when attaching it.
- When it will go no further, remove the whisk holder from the aluminium casing.

Fitting the whisks into the whisk holder

- Grasp the holder in one hand.
- With the other hand, take the first whisk and insert the shaft **A** into the bore **B** of the whisk holder drive shaft. Make sure the drive lugs **D** are properly aligned with the notches.
- As you push the whisk into the whisk holder drive shaft **C**, rotate it slightly in order to slot the drive lugs into the notches **E** of the drive shaft **C**, thereby locking the whisk into place inside the shaft.
- To check that the whisk is properly fixed inside the shaft **C**, gently tug the metal wires.
- Repeat this procedure with the second whisk. If you cannot push it in properly, remove it, rotate it 90° and start again.

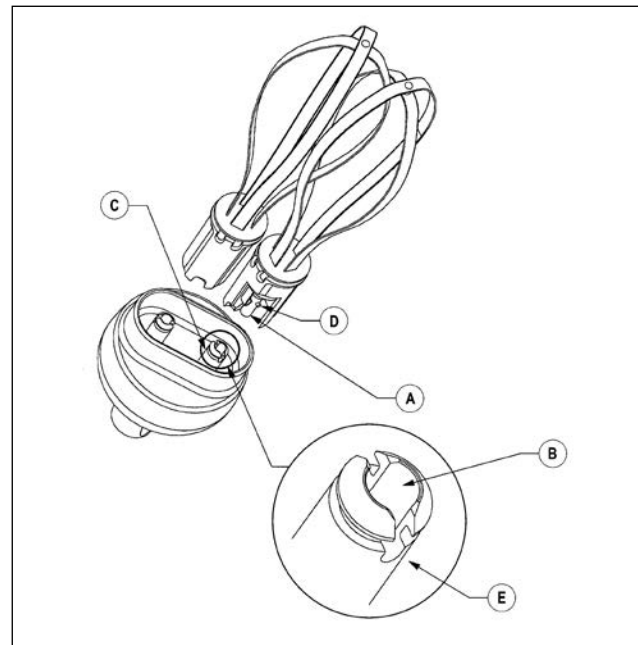

Removing the whisks from the whisk holder

Pull the ejector **A** in direction to the arrow, gripping the ejector in one hand and the holder **B** in the other.

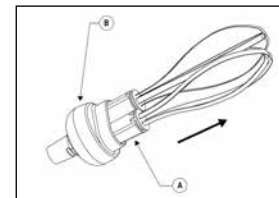

Removing the ejector

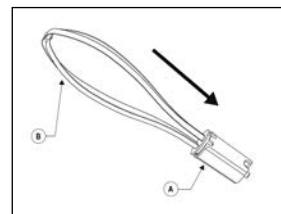

- Hold the whisk by the wires **B** in one hand.
- With the other hand, pull the ejector **A** in the direction of the arrow (see figure).

The foot, the blades and the whisks can be entirely dismantled, (Robot-Coupe's exclusive patented system), thereby ensuring easy cleaning, perfect hygiene and simple maintenance.

PAN SUPPORT

They enable the user to tilt the power mixer without any effort or else to leave it running on its own. All stainless steel and completely dismantled, they are easy to clean and very practical to use.

• UNIVERSAL SUPPORT

For any pans diameter.



• ADJUSTABLE SUPPORT

3 pan supports are available as an option. They can be adapted to the three following sizes of pans:

- Ø pan: from 330 mm to 650 mm.
- Ø pan: from 500 mm to 1,000 mm.
- Ø pan: from 850 mm to 1,300 mm.



HYGIENE

The equipment must be clean at all stages of production.

It is vital to clean the power mixer thoroughly between each job using a disinfectant / detergent.

• N.B. NEVER USE PURE BLEACH

- **Do not use the following products:**
 - Abrasive cleaning products;
 - Solvents;

- Scouring pads;
 - Powder detergents.
- These products can damage the metal and plastic surfaces of the mixer.

CLEANING



WARNING

As a precaution, always unplug your appliance before cleaning it (risk of electrocution).

After using the power mixer in a hot preparation, cool the bottom of the foot in cold water before dismantling the bell from the foot.

After completion of preparation, clean immediately to prevent food from sticking to surfaces.

• MOTOR UNIT

Never put the motor unit and its handle in water, clean them with a damp cloth or a sponge.

• FOOT AND BELL

It is possible to proceed in two ways:

AFTER EACH USE

- 1) Fill an appropriate container with hot water at 60 to 70°C and add dishwashing liquid. Turn on the mixer for 20 seconds.
- 2) Unplug the mixer.
- 3) Using a brush, clean the outside of the tube and bell with hot water and, if necessary, with the detergent used above.
- 4) Rinse in warm water. Plug in the mixer again and turn on for another 10 to 15 seconds.

AT THE END OF THE DAY

- 5) After disconnecting the mixer, **detach the bell from the foot to remove any condensation.**
- 6) Carefully dismantle the different parts of the bell using the tool provided taking care not to damage the blade shaft surfaces and cartridge gaskets. Clean each part using a mild detergent. The blades are sharp and must be handled with care.
- 7) Immerse the foot, detached from the bell, in a mild detergent solution for one minute. Rinse and let dry before re-attaching the bell.
- 8) After cleaning, dry all the parts carefully to prevent oxidation.



WARNING

The inside of the bell must not contain any liquid or food matter besides condensation.

If any liquid or food matter should get inside the bell, you must:

- **Change the ring/blade assembly (Ref. 89676),**
- **Clean and disinfect the bell and the end of the foot to avoid all risk of contamination.**

After each use:

- **It is important to detach the bell to eliminate any condensation and ensure no food matter has seeped inside. To eliminate condensation, simply leave the bell detached until it dries.**
- **When cleaning the bell and the end of the foot, we recommend using a mild detergent.**

• BLADES

The blades can be removed from the bell for thorough cleaning.

Always dry the blades thoroughly after cleaning to avoid spotting.

• WHISK HOLDER

Never immerse the whisk holder in water. Clean it with a slightly damp cloth or sponge.

Never clean the whisk holder in a dishwasher.

• WHISKS

The whisks can be cleaned either by hand or in a dishwasher.

To ensure effective cleaning, we advise you to remove the whisk ejector.



IMPORTANT

Check that your detergent is suitable for cleaning plastic parts. Some washing agents are too alkaline (e.g. high levels of caustic soda or ammonia) and totally incompatible with certain types of plastic, causing them to deteriorate rapidly.

MAINTENANCE

• BLADES

The performance of the cut essentially depends on the state of your blades and their wear. The blades are subject to wear and as such need to be replaced from time to time to ensure the consistent quality of the end product.

You are also advised to change, at the same time, the washer and the watertight seals.

• WHISKS

The success of your preparation will depend essentially on the state of the metal wires and their amount of wear and tear. They should therefore be replaced from time to time in order to ensure optimum quality of the finished product.

• POWER CORD:

For your safety, make sure the power cord is always in good condition. The cord is subjected to considerable wear and tear, and must be replaced if it is damaged in any way (cuts, burns, etc.).

Procedure for replacing the power cord:

- 1) Use the dismantling tool supplied with the new replacement cord.
- 2) Press the push button (see photo) and pull on the cord without releasing the dismantling tool.

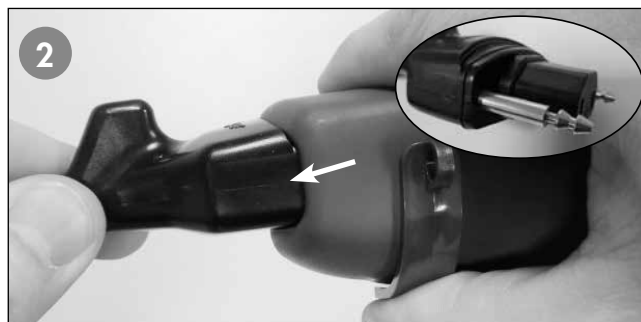
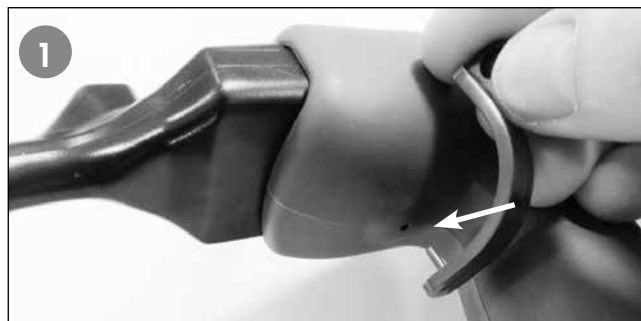

3) Installing the new cord:

Connect the Easy-Plug to the motor housing.

Before doing so, make sure the electrical plug is not connected to the power supply.

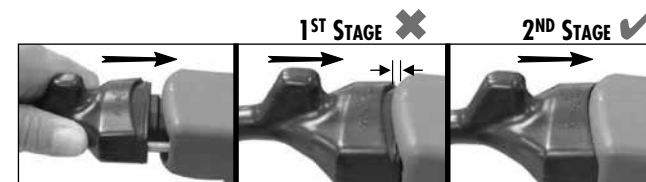

Connect the electrical plug to the power supply.



Make sure the plug is pushed in far enough (two stages). If it is not, the control buttons will not work.

After the cord has been connected to the handle and plugged into the mains, a green indicator light indicates the presence of electrical current in the cord, the correct connection of the cord to the appliance and the correct operation of the cable.

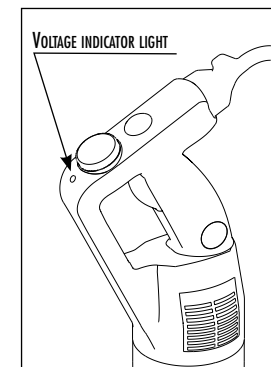

• FOOT SEAL

In order to maintain a perfect watertight seal between the foot and the bell it is necessary to check the wear of the seal regularly and replace it if necessary.

• **WASHER**

The washer can be greased using a suitable food safe lubricant.

In order to maintain a perfect watertightness it is necessary to check the wear of the washer, and if necessary, to replace it.



WARNING

From time to time, check:

- The state of the 3 buttons' watertight membranes. Even the tiniest cracks will allow liquid to seep in.
- The state of the blender housing. This, should not show any signs of cracking or any abnormal openings which could allow access to the live components.

TECHNICAL SPECIFICATIONS

• **WEIGHT**

	Net	Gross
CMP 250 V.V.	3.3 kg	3.9 kg
CMP 300 V.V.	3.4 kg	4.0 kg
CMP 350 V.V.	3.7 kg	4.2 kg
CMP 400 V.V.	3.8 kg	4.3 kg
CMP 250 Combi		
with mixer	3.4 kg	5.6 kg
with whisk	3.6 kg	
CMP 300 Combi		
with mixer	3.6 kg	5.7 kg
with whisk	3.6 kg	

• **DIMENSIONS (in mm)**

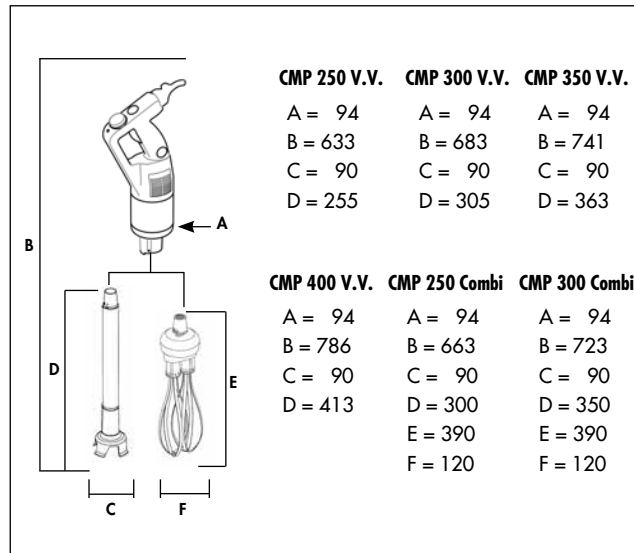

• **WORKING HEIGHT**

We recommend that you ensure that the container is placed on a stable and solid work surface.

• **NOISE LEVEL**

The equivalent continuous sound level when the foot is not immersed in anything is less than 70 dB (A).

• **ELECTRICAL DATA**

Single-phase machine
CMP 250 V.V. / CMP 250 Combi

Motor	Mixer Speed (rpm)	Whisk Speed (rpm)	Intensity (Amp.)
230 V/50 Hz	2,300 to 9,600	500 to 1,800	1.4
120 V/60 Hz	2,300 to 9,600	500 to 1,800	2.6
220 V/60 Hz	2,300 to 9,600	500 to 1,800	1.3

Single-phase machine
CMP 300 V.V. / CMP 300 Combi

Motor	Mixer Speed (rpm)	Whisk Speed (rpm)	Intensity (Amp.)
230 V/50 Hz	2,300 to 9,600	500 to 1,800	1.6
120 V/60 Hz	2,300 to 9,600	500 to 1,800	2.9
220 V/60 Hz	2,300 to 9,600	500 to 1,800	1.4

Single-phase machine **CMP 350 V.V.**

Motor	Mixer Speed (rpm)	Intensity (Amp.)
230 V/50 Hz	2,300 to 9,600	1.7
120 V/60 Hz	2,300 to 9,600	3,1
220 V/60 Hz	2,300 to 9,600	1.6

Single-phase machine **CMP 400 V.V.**

Motor	Mixer Speed (rpm)	Intensity (Amp.)
230 V/50 Hz	2,300 to 9,600	1.9

- Power shown on data plate.

SAFETY



WARNING

The blades are sharp tools, handle them with care.

ROBOT-COUPE power mixers are equipped with a safety system comprising of a :

- Safety control button
- Thermal and overload protection
- No volt release a supply failure.
- Power cord safety

• Safety control button

This safety mechanism prevents any unintentional starting of the power mixer. In fact, it is necessary to press down two buttons to start the power mixer. In order to start the machine, read the paragraph entitled OPERATING THE APPLIANCE (page 6).

• Thermal protection system

If the appliance is left running for too long, the thermal protection system will automatically shut it down. If this happens, wait for the appliance to cool down completely (approx. 30 min.) before following the procedure for OPERATING THE APPLIANCE (page 6).

• No volt release a supply failure

In the event of a power cut or after the machine has been unplugged, the power mixer will not restart by itself. It is necessary to follow the steps in the paragraph entitled OPERATING THE APPLIANCE (page 6).

• Power cord safety

Before you connect the power cord to the mains supply, always check that this cord:

- 1°) is not damaged in any way;
- 2°) has been properly connected to the machine handle. If this is not the case, follow the procedure for SWITCHING ON THE APPLIANCE (page 6).



REMINDER

Never try to override the locking and safety mechanisms.

Never insert an object into the preparation.

Never switch the appliance on unless it has been placed in the preparation bowl.

Before dismantling the foot, bell or whisk, always check that the power mixer is unplugged.

We recommend that you tilt the power mixer at a slight angle to prevent the bell from touching the bottom of the container.

PROBLEMS

At first, try to identify precisely what has caused the power mixer to stop.

- **If it is due to a powercut if the appliance has been unplugged (the green voltage indicator light is off).**
 - Release the control button (CB).
 - Check the power supply.
 - Restart the power mixer following the paragraph entitled OPERATING THE APPLIANCE (page 6).
- **If it is due to overheating of the machine (the green voltage indicator light stays on)**
 - Release the control button (CB).
 - Unplug the power mixer.
 - Wait a few minutes for the motor to cool down and the thermal safety mechanism to be reset.
 - Restart the power mixer following the paragraph entitled OPERATING THE APPLIANCE (page 6).

• If you cannot locate the cause of the problem

- Release the control button (CB).
- Unplug the power mixer.
- Check:
 - the plug
 - that the blades are free to rotate in the bell,
 - the state of the power cord,
 - that the drive shaft is free to rotate. To do this, remove the bell and test the rotation of the end of the drive shaft manually.

• If the green voltage indicator light is off, check:

- The network voltage
- Correct connection of the cable to the wall plug.
- Correct attachment of the cord to the handle (see page 11).
- The state of repair of the cord (any cut wires) if this is the case, see replacement procedure on page 11.

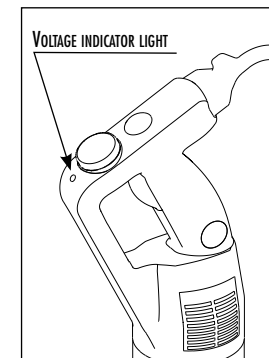

If a malfunction occurs which is not on our list of possible faults, consult your retailer or return the appliance to the after-sales service.

STANDARDS

Consult the declaration of compliance on page 2.

robot  *coupe*®

TECHNICAL DATA

CMP250 V.V. - CMP300 V.V. - CMP350 V.V. - CMP400 V.V. - CMP250 Combi - CMP300 Combi - CMP250 FW
 120V/60Hz - 220V/60Hz - 220-240V/50Hz 1~

SCHEMA ELECTRIQUE

ELECTRIC DIAGRAM

ELEKTRISCHES SCHALTBILD

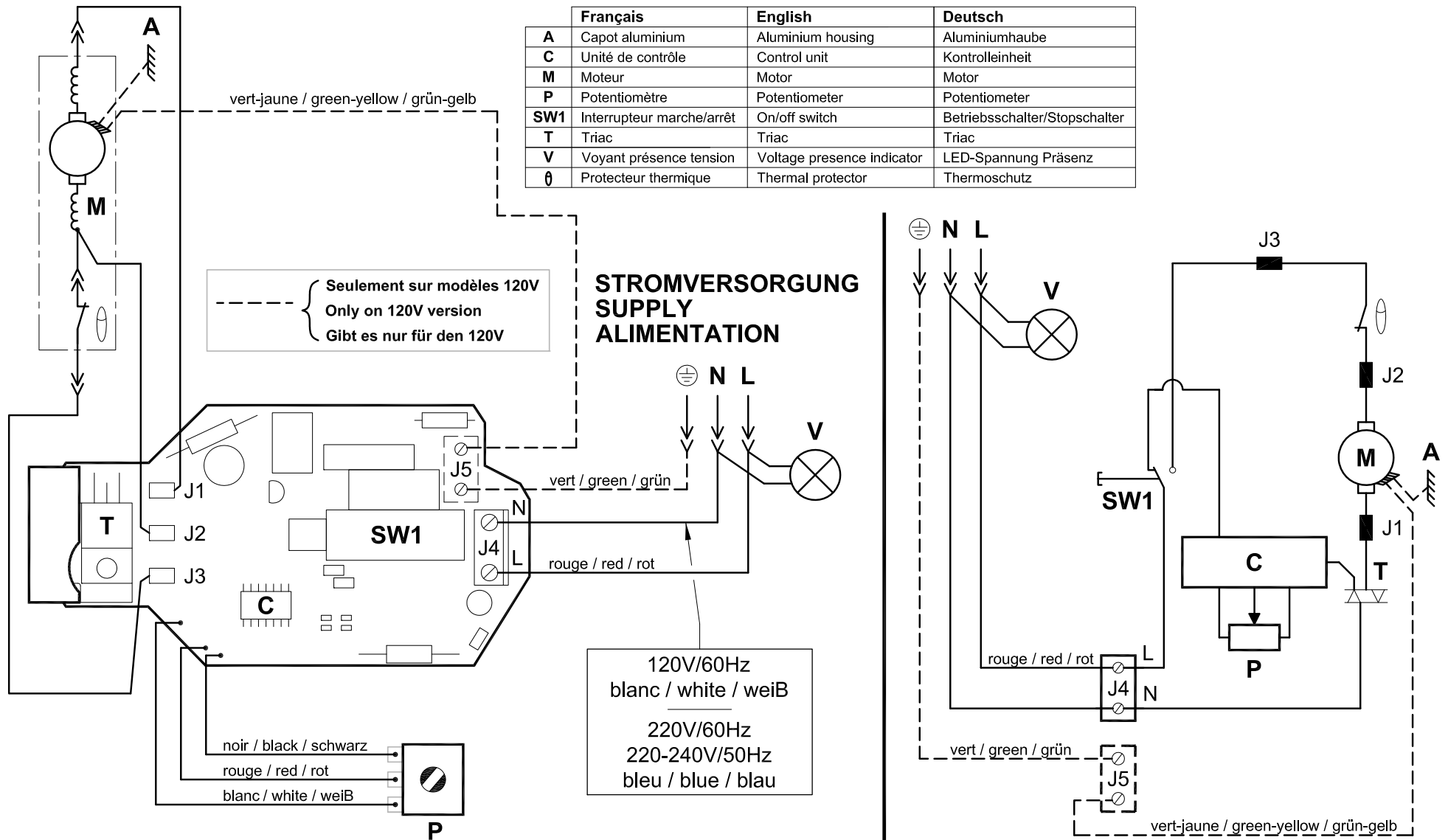



robot coupe®

**Head Office, French,
Export and Marketing Department:**
48, rue des Vignerons
94305 Vincennes Cedex- France
Tel.: 01 43 98 88 15
Email: international@robot-coupe.com

**Robot Coupe
Australia Pty Ltd:**
Unit 3/43 Herbert St
Artarmon NSW 2064 Australia
Tel.: (02) 9478 0300
Email: orders@robotcoupe.com.au

**Robot-Coupe
U.K. LTD:**
Fleming Way, Isleworth,
Middlesex TW7 6EU
Tel.: 020 8232 1800
Email: sales@robotcoupe.co.uk



37002314451778

Réf. : 451 778 - 01/04/2021